

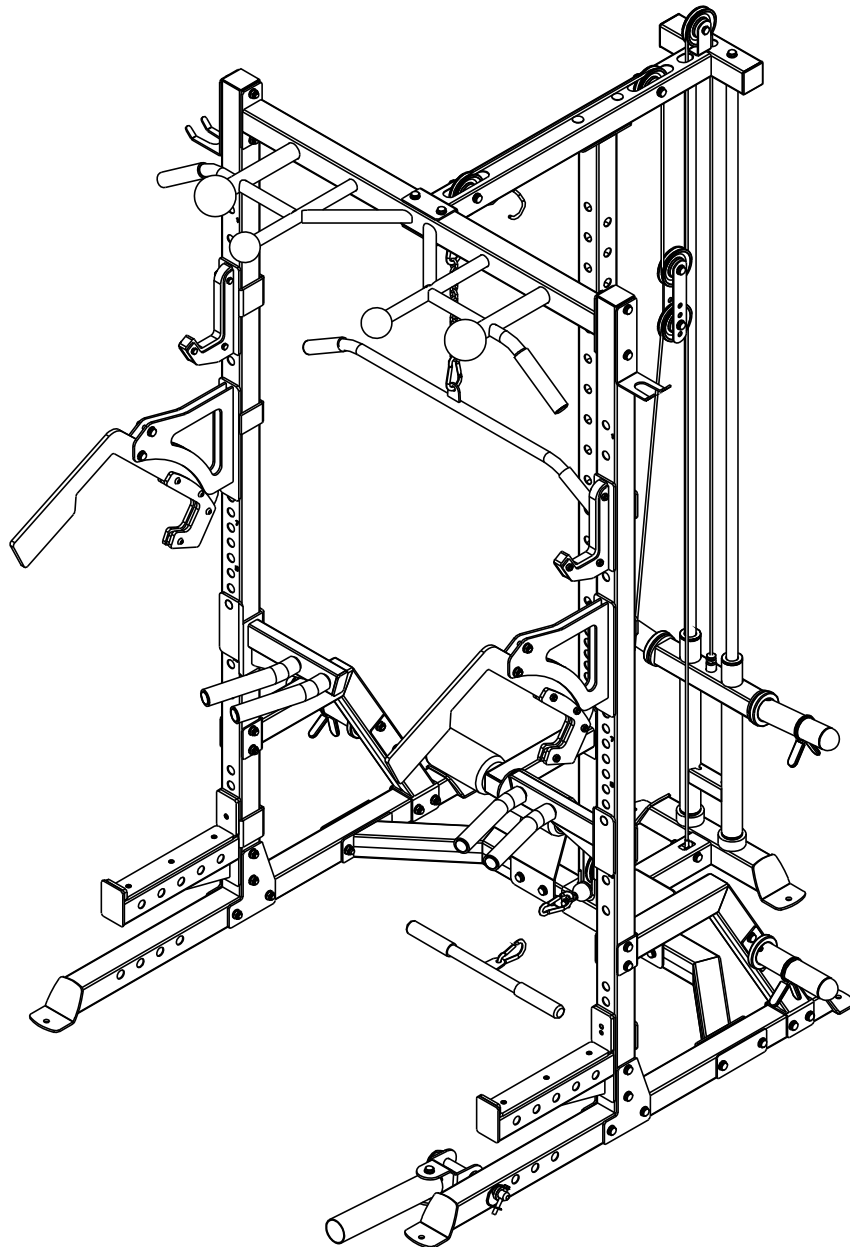

PRIMAL[®]

PRIMAL PERSONAL SERIES ULTIMATE HALF RACK



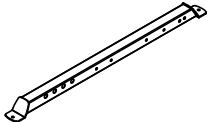

PSPR0069

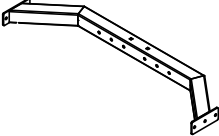
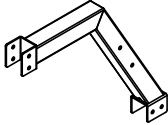
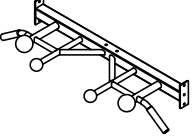
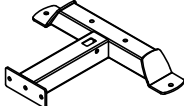
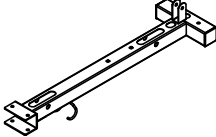
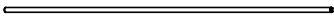
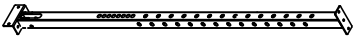
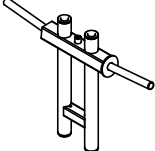

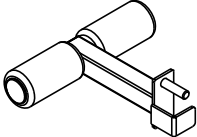
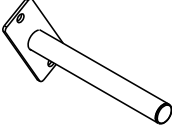
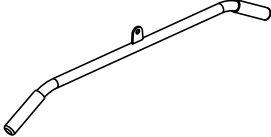
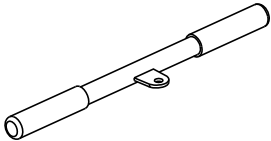
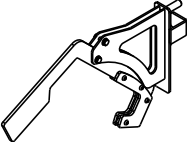
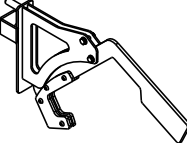
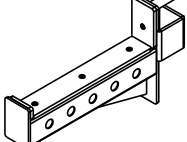
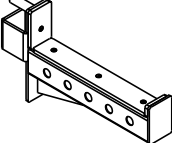
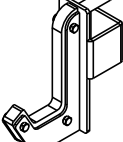
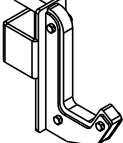
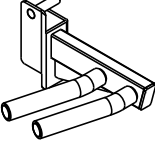

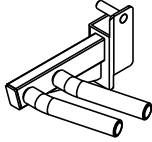
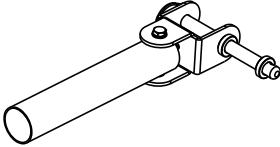
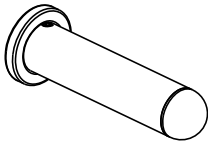

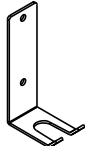
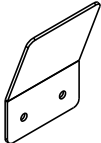
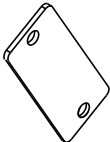
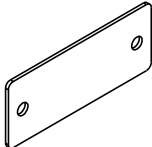
PART LIST

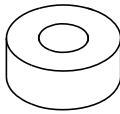
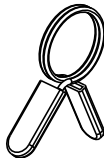
NUMBER	DESCRIPTION		QUANTITY
1	BASE		2
2	UPRIGHT FRAM		2
3	CROSS BEAM		1
4	UPRIGHT FRAM SUPPORT		2
5	CROSS BAR		1
6	BACK BASE		1
7	MIDDLE UPPER POST		1
8	GUIDE ROD		2
9	BACK UPRIGHT FRAM		1
10	SLIDING WEIGHT POST		1

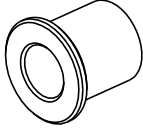
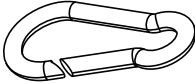

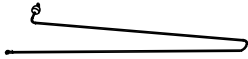
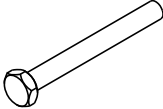
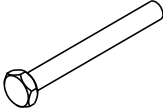
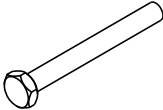
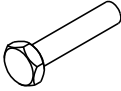
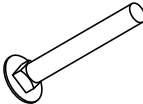
11	LEG HOLDER ASSEMBLY		1
12	STORAGE TUBE		2
13	LAT PULL DOWN BAR		1
14	LOW ROW BAR		1
15	SAFETY BRACKET		1
16	RIGHT SAFETY BRACKET		1
17	LEFT SAFETY BAR		1
18	RIGHT SAFETY BAR		1
19	LEFT J HOOK		1
20	RIGHT J HOOK		1
21	LEFT SUPPORT		1

22	RIGHT SUPPORT		1
23	BAR SUPPORT		1
24	OLYMPIC PLATE BAR		4
25	PLATE		4
26	OLYMPIC BAR STORAGE		2
27	FOOT PLATE		2
28	STRENGTHEN PLATE		2
29	BIG STRENGTHEN PLATE		2
30	BRACKET		2
31	SLIDING SLEEVE		2
32	OLYMPIC SPRING CLIP		4

33	PULLEY		6
34	BUSHING		6
35	HOOK		4
36	CHAIN		1
37	CABLE WITH BOLT		1
38	CABLE		1
39	BOLT M10*85		32
40	BOLT M10*80		7
41	BOLT M10*75		3
42	BOLT M10*45		3
43	SCREW M10*75		6
44	WASHER 10		92
45	LOCK NUT M10		47

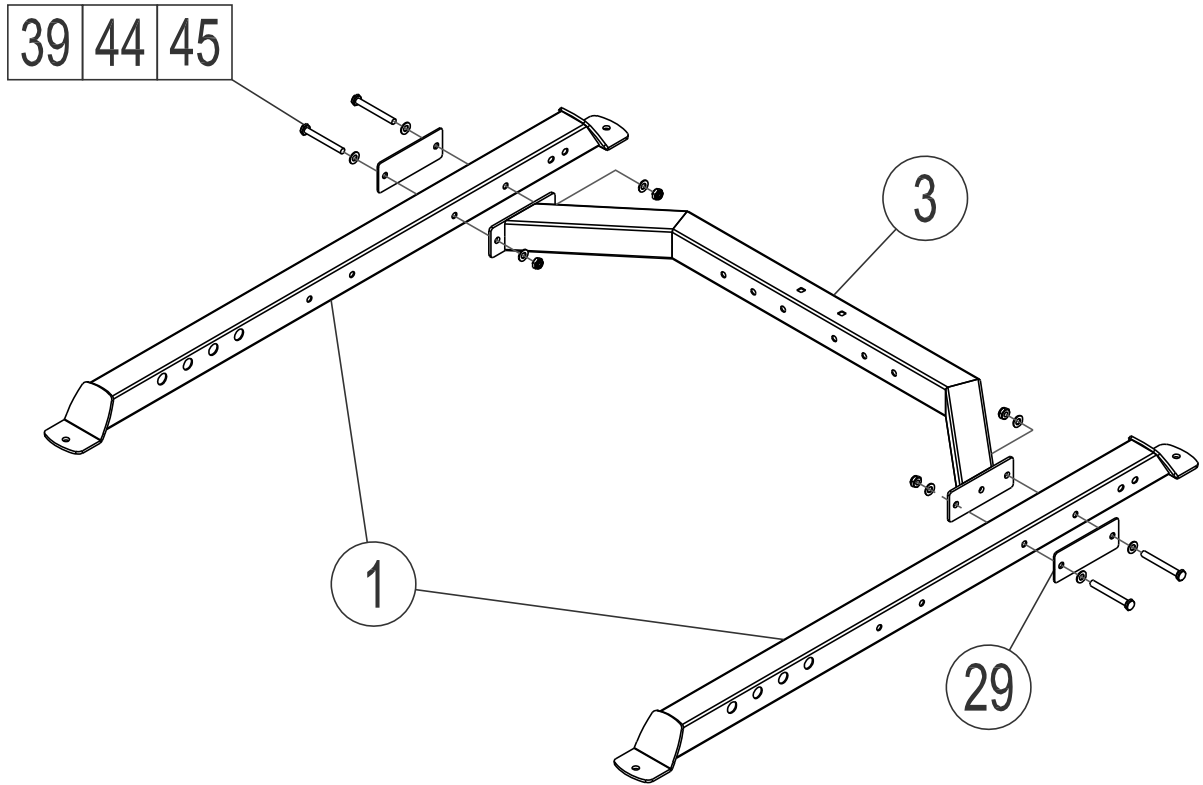

STEP 01



39#		M10*85	Qty:4
44#		10	Qty:8
45#		M10	Qty:4

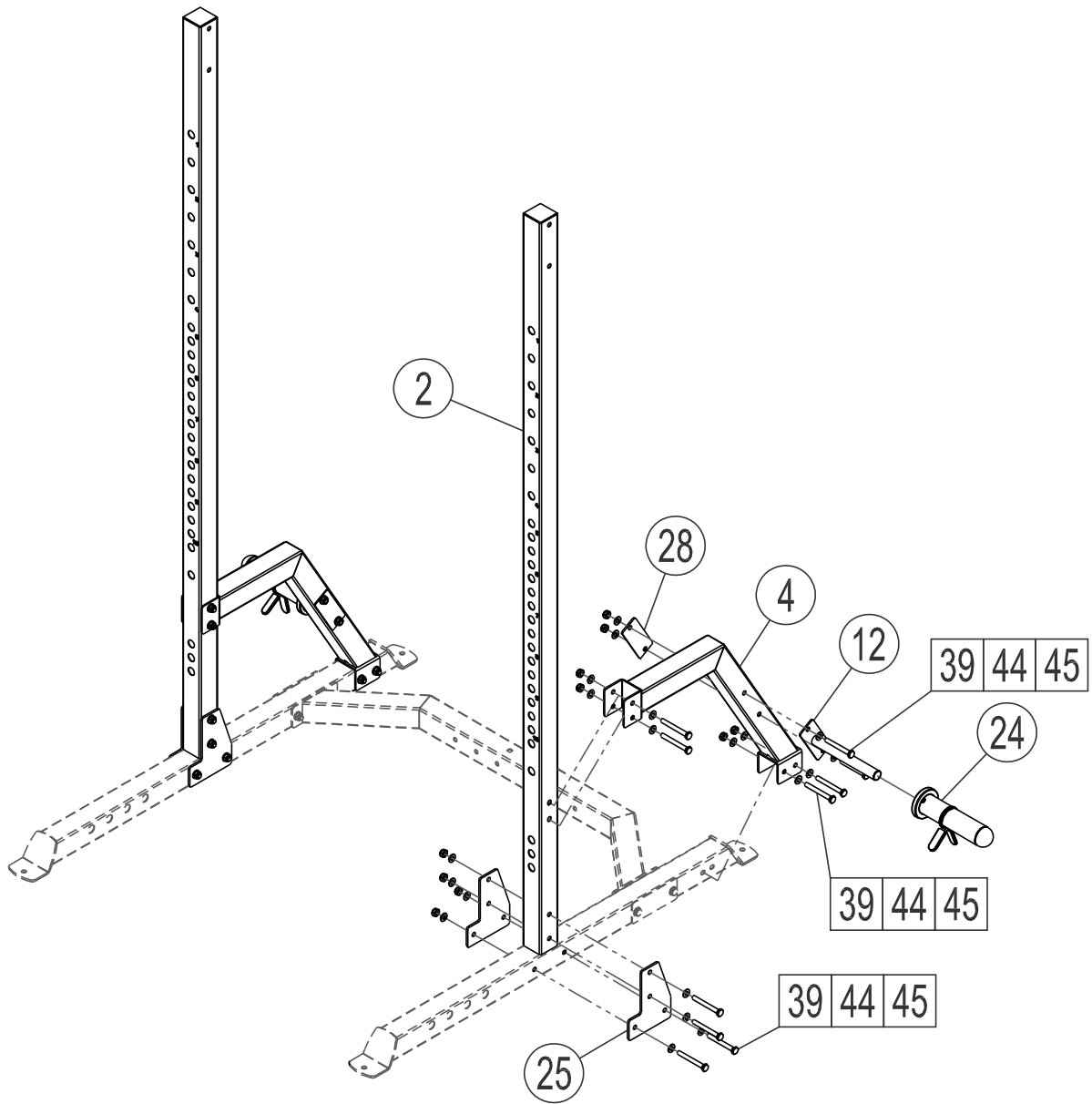

STEP 02



39#		M10*85	Qty:20
44#		10	Qty:40
45#		M10	Qty:20

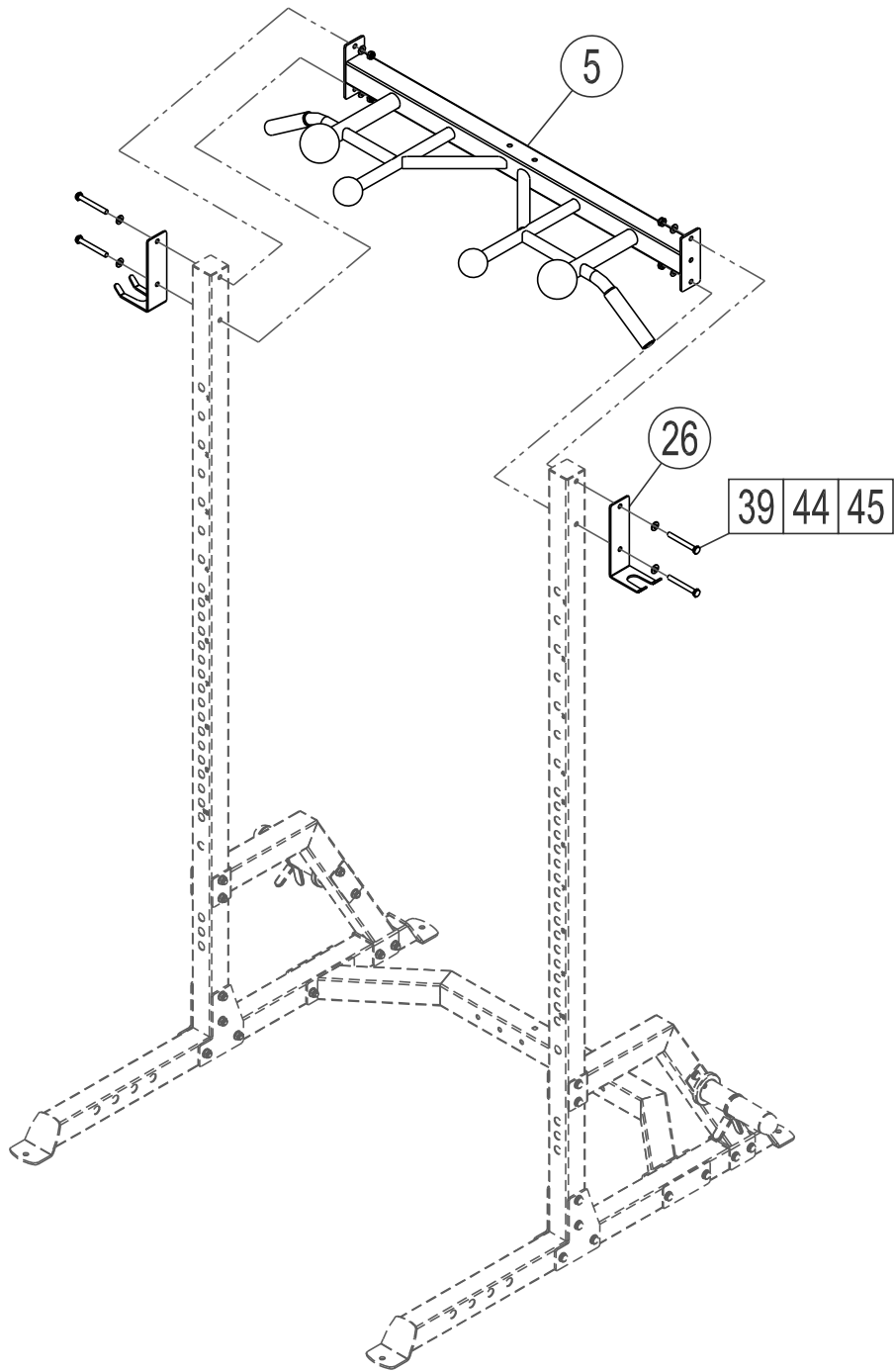



STEP 03

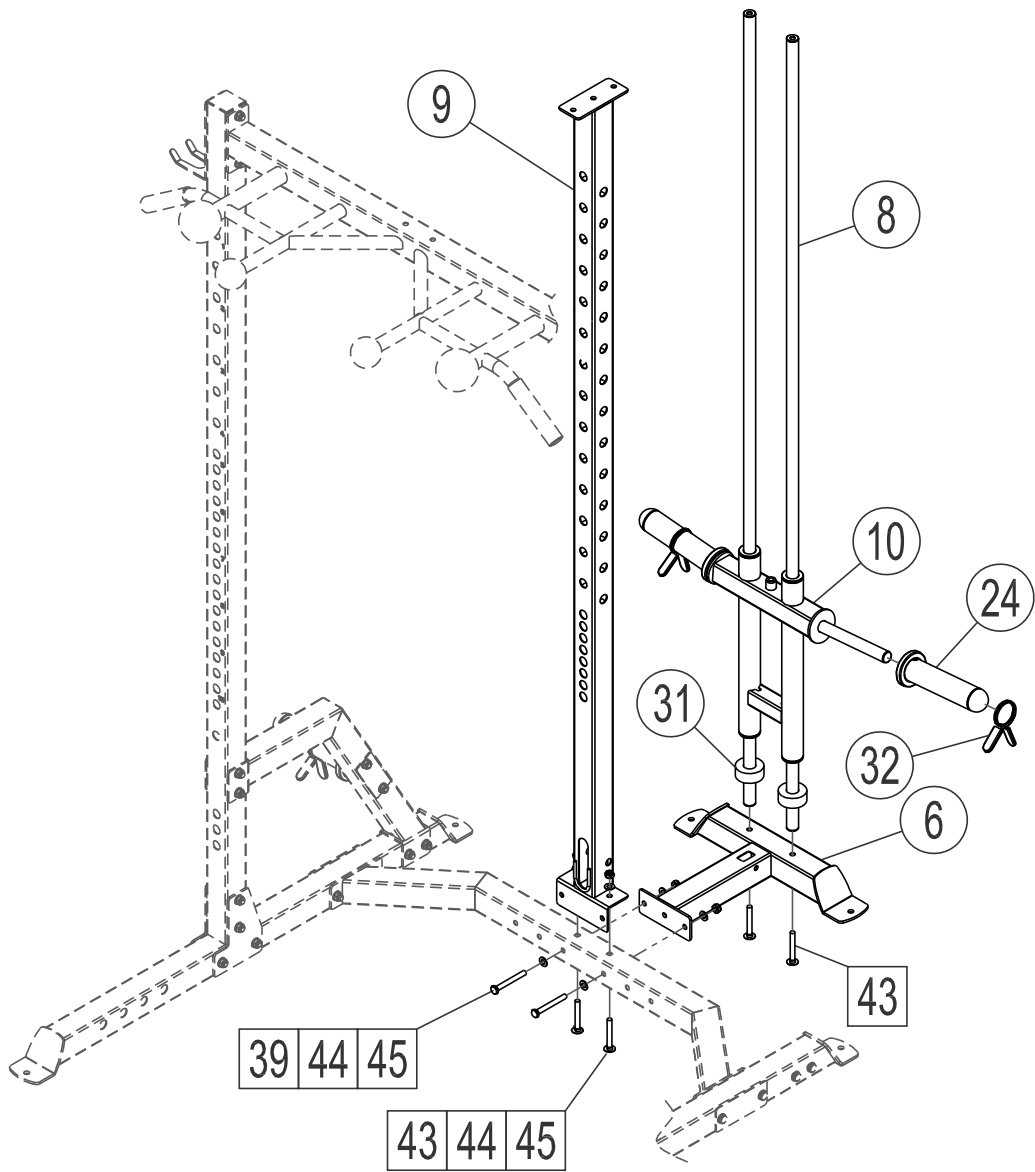

39#		M10*85	Qty:4
44#		10	Qty:8
45#		M10	Qty:4





STEP 04

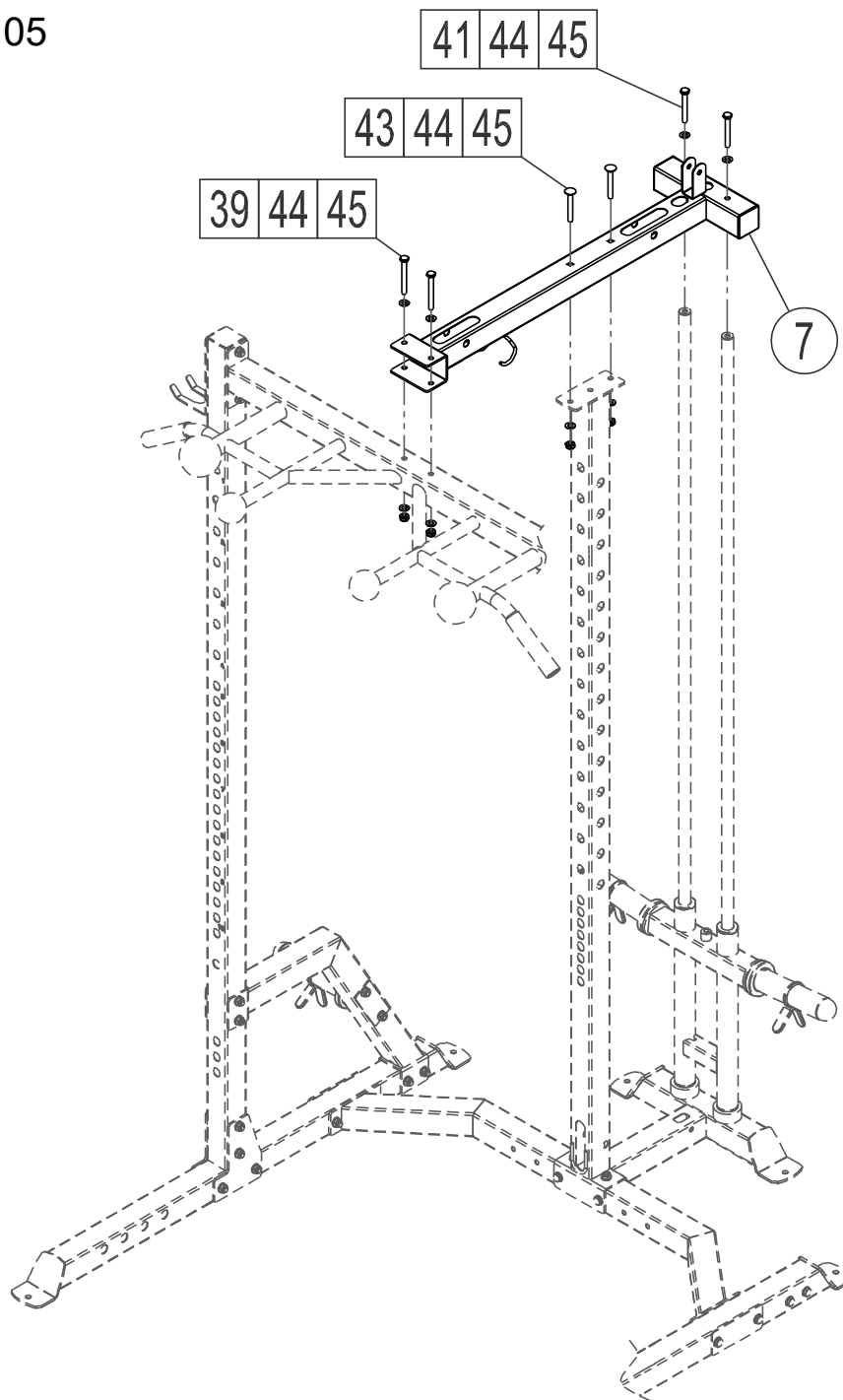

39#		M10*85	Qty:2
43#		M10*75	Qty:4
44#		10	Qty:6
45#		M10	Qty:4

STEP 05



39#		M10*85	Qty:2
41#		M10*75	Qty:2
43#		M10*75	Qty:2
44#		10	Qty:8
45#		M10	Qty:4

STEP 06

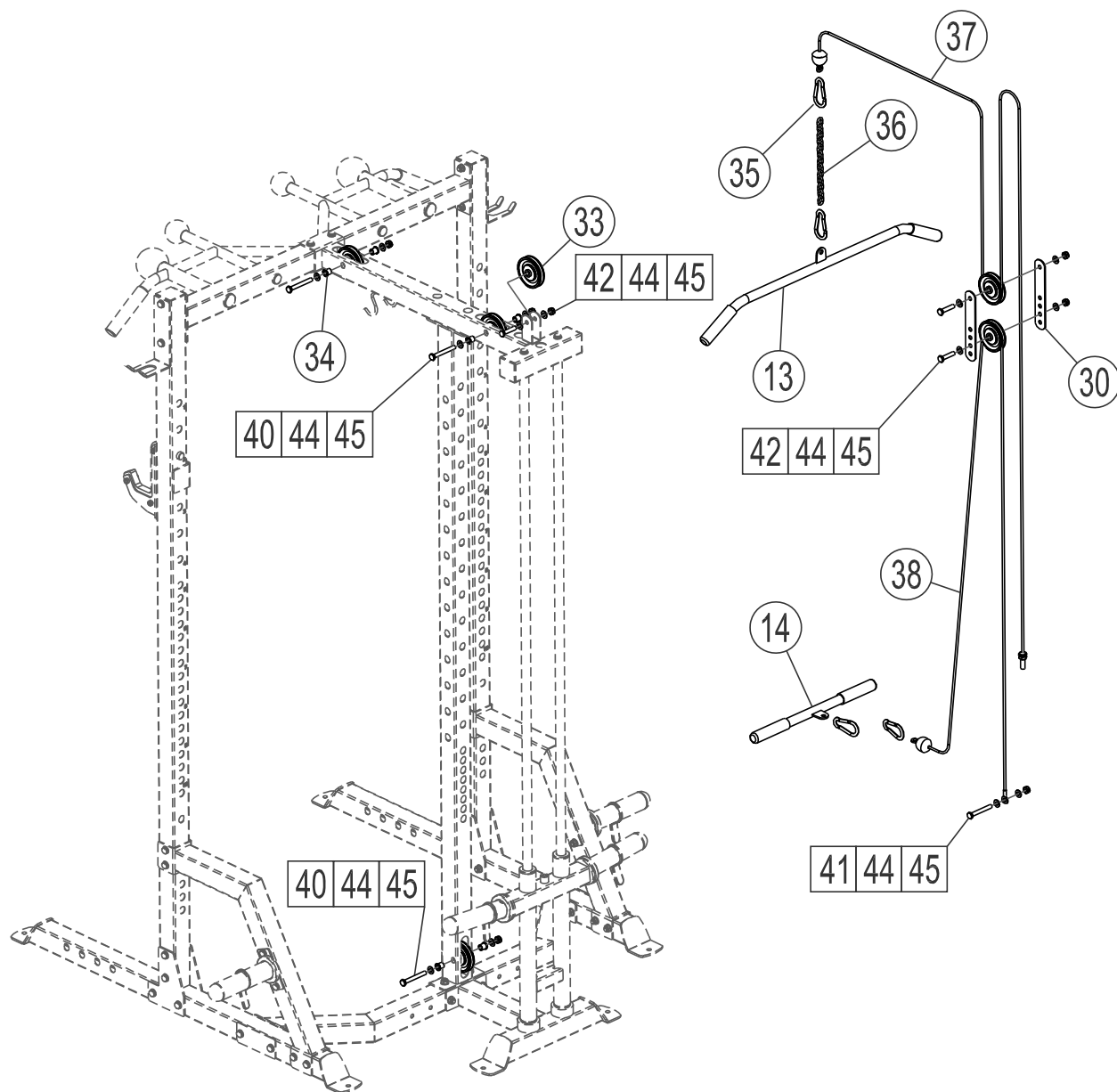



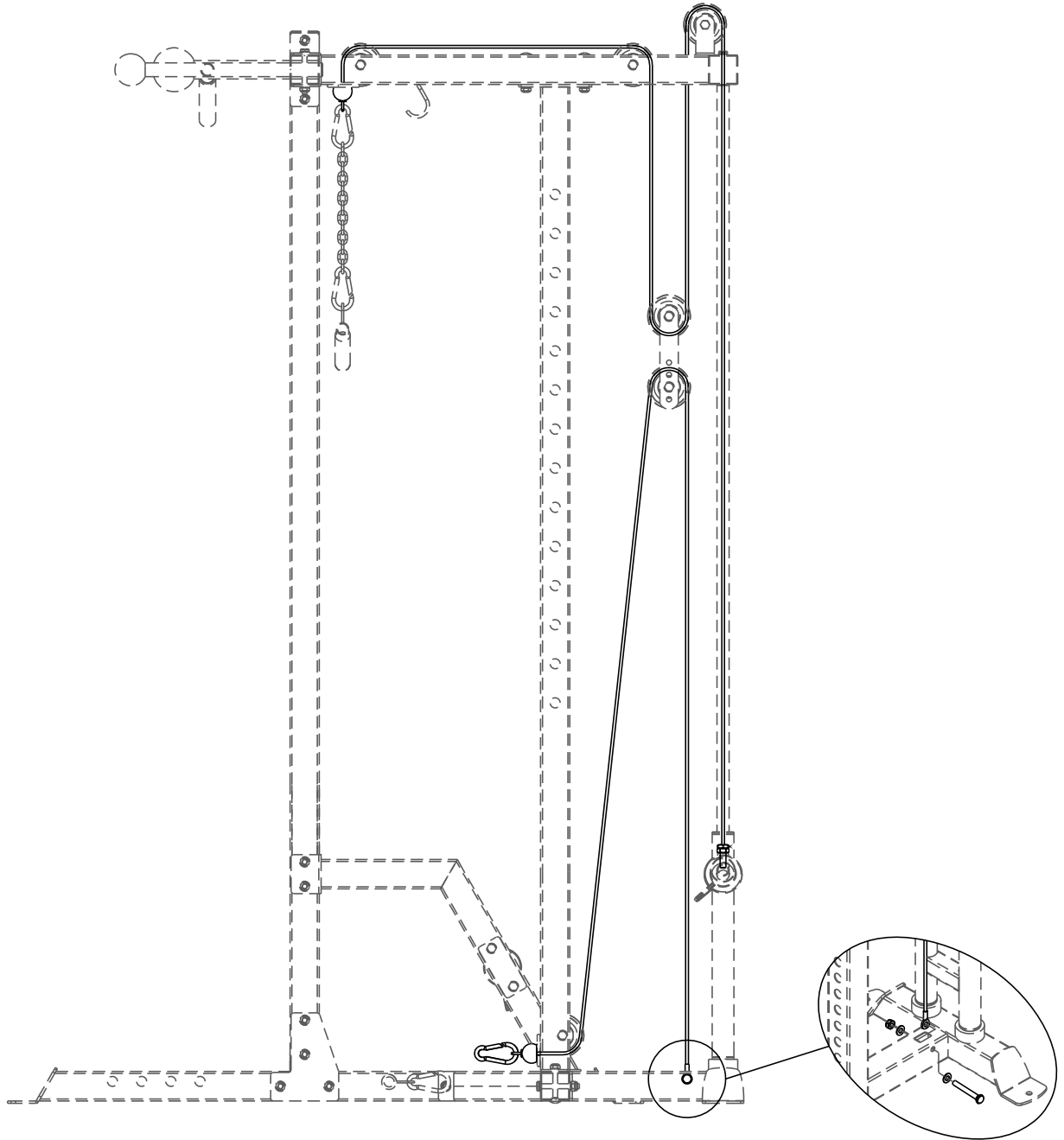

40#		M10*80	Qty:3	44#		10	Qty:14
41#		M10*75	Qty:1	45#		M10	Qty:7
42#		M10*45	Qty:3				

STEP 07

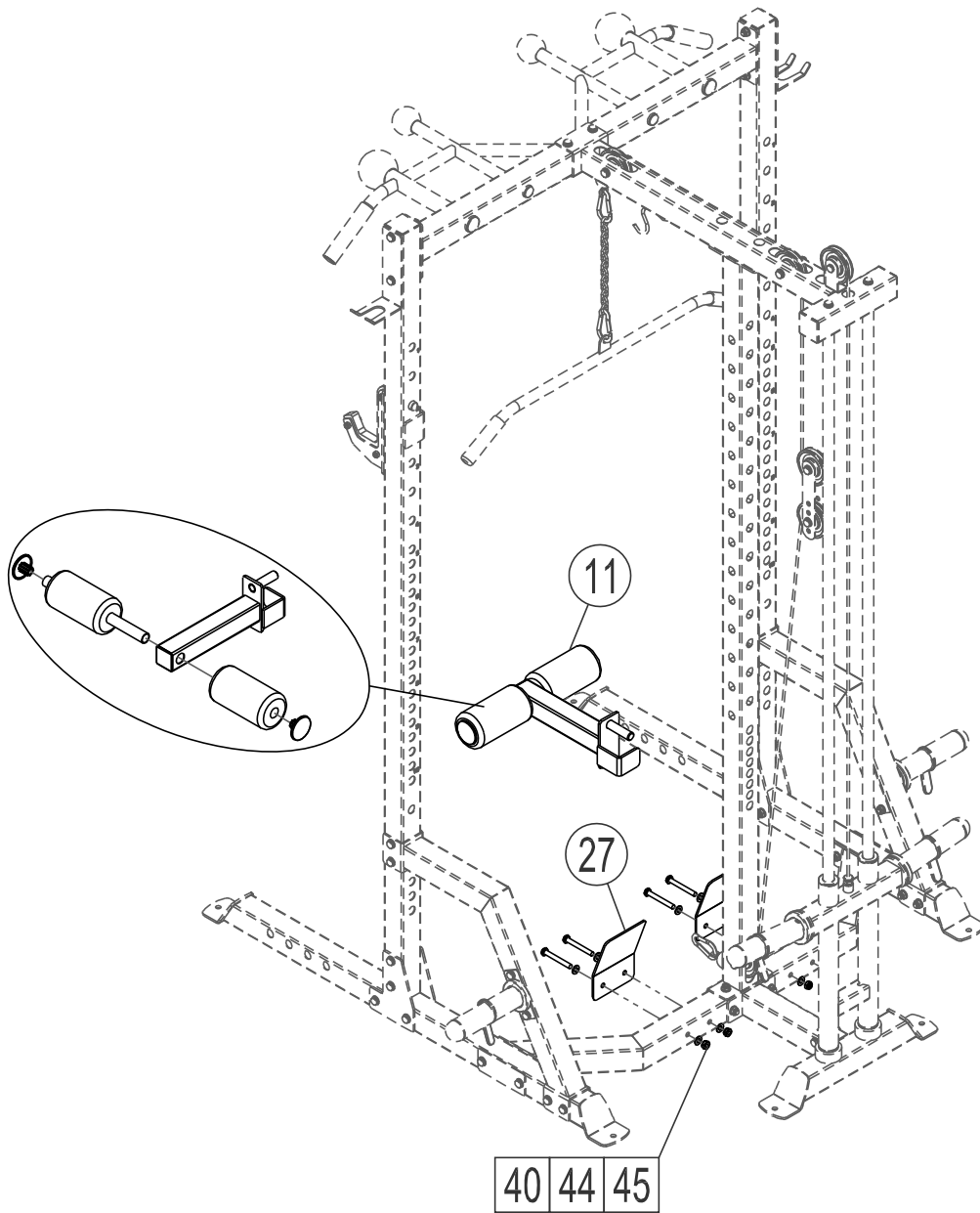

STEP 08



40#		M10*80	Qty:4
44#		10	Qty:8
45#		M10	Qty:4

STEP 09

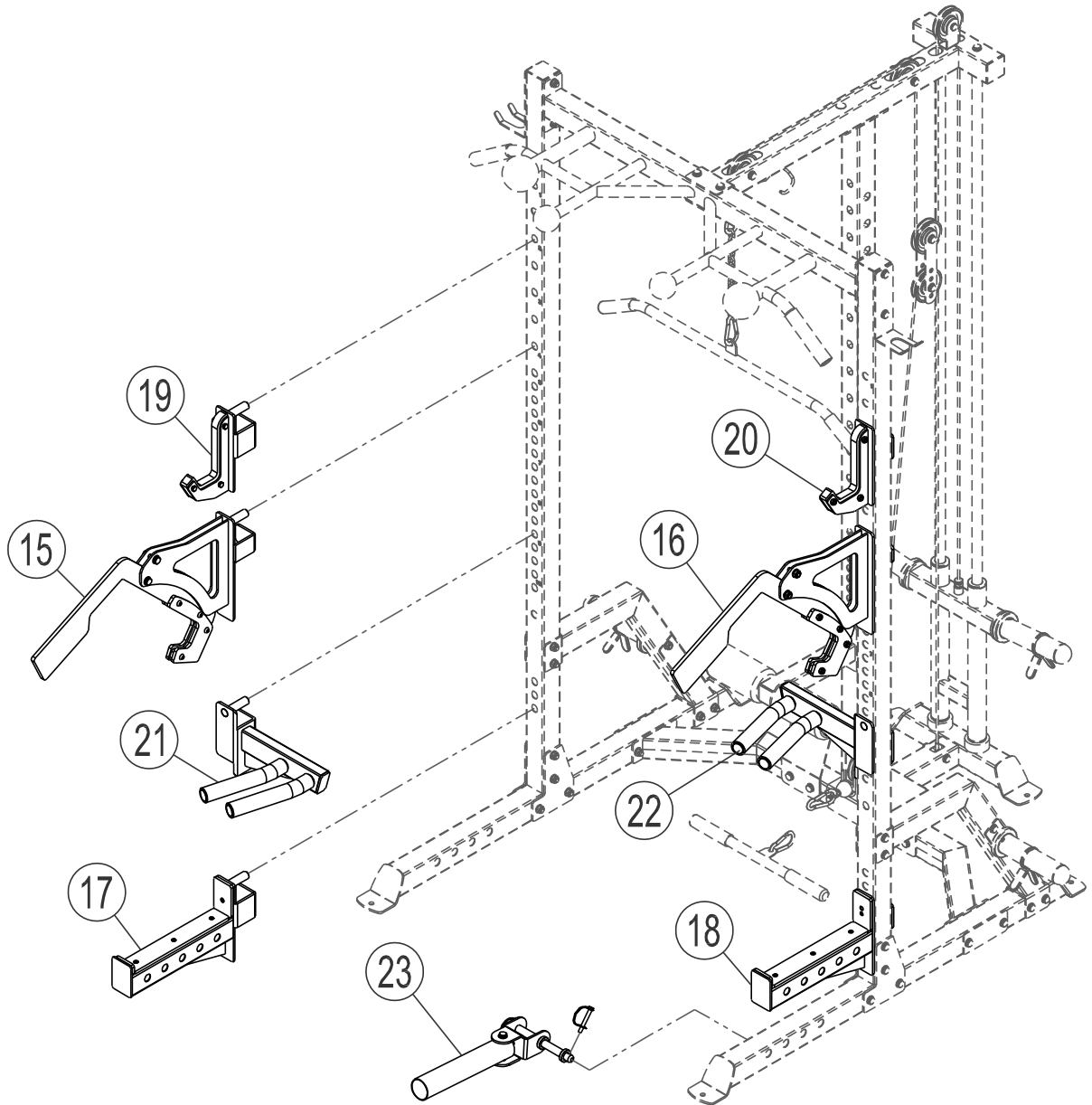

M10*85×32PCS

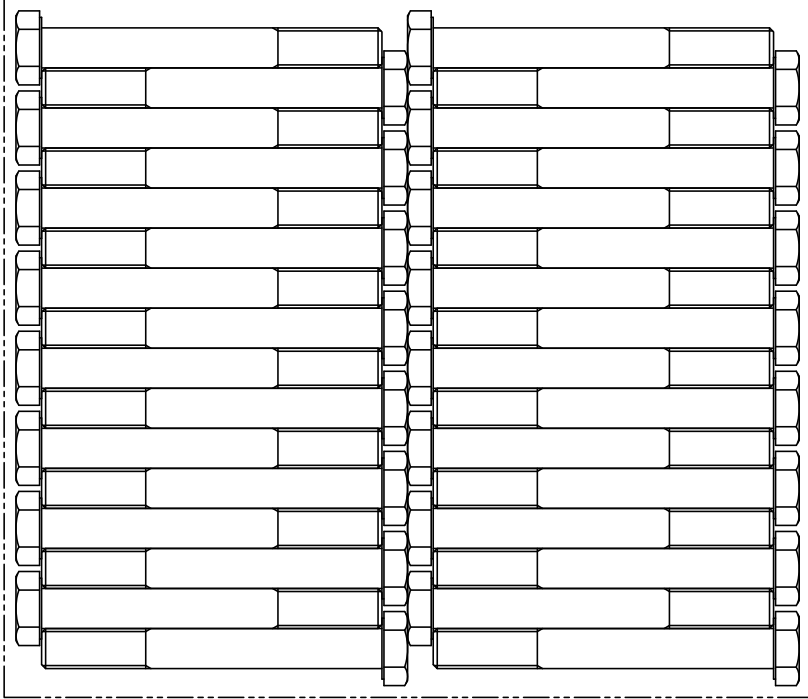

M10*75×6PCS

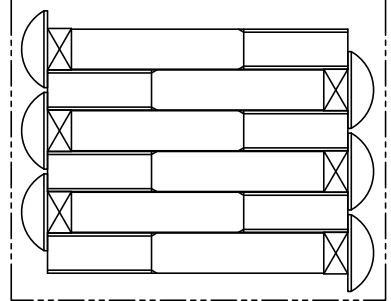

Ø10×92PCS

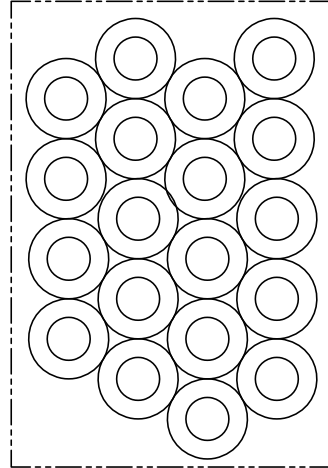

M10*75×3PCS

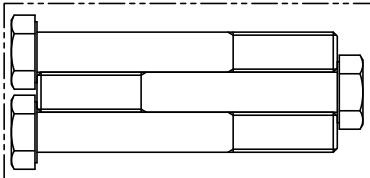

M10*45×3PCS

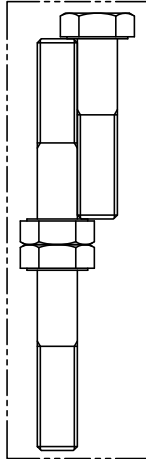



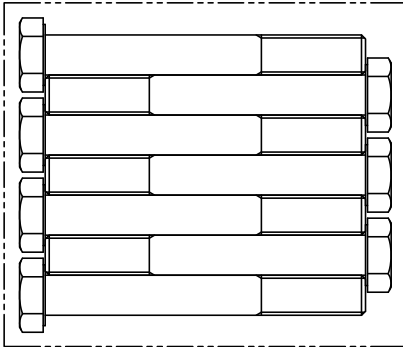



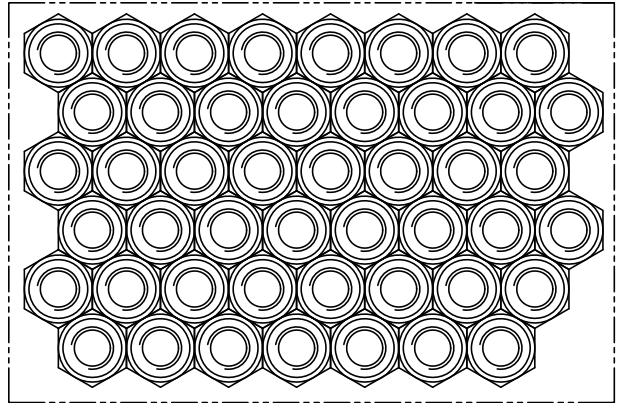



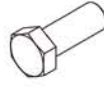





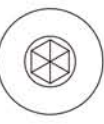
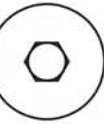

M10*80×7PCS











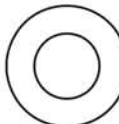
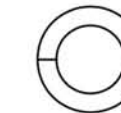

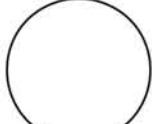
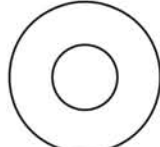
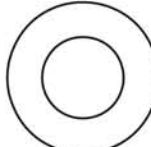
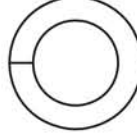
M10×47PCS

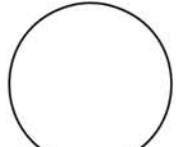
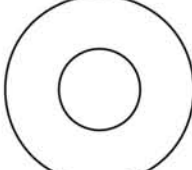
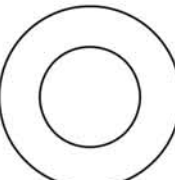
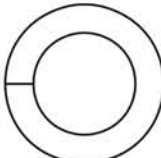

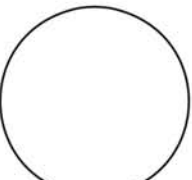
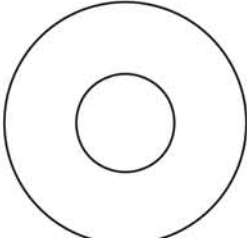
SIZE CHART

					
M8					
M10					
M12					

M8					
M10					
M12					
	Washer 	Spring Washer 	Lock Nut 	Nut Cap 	Big Washer 